

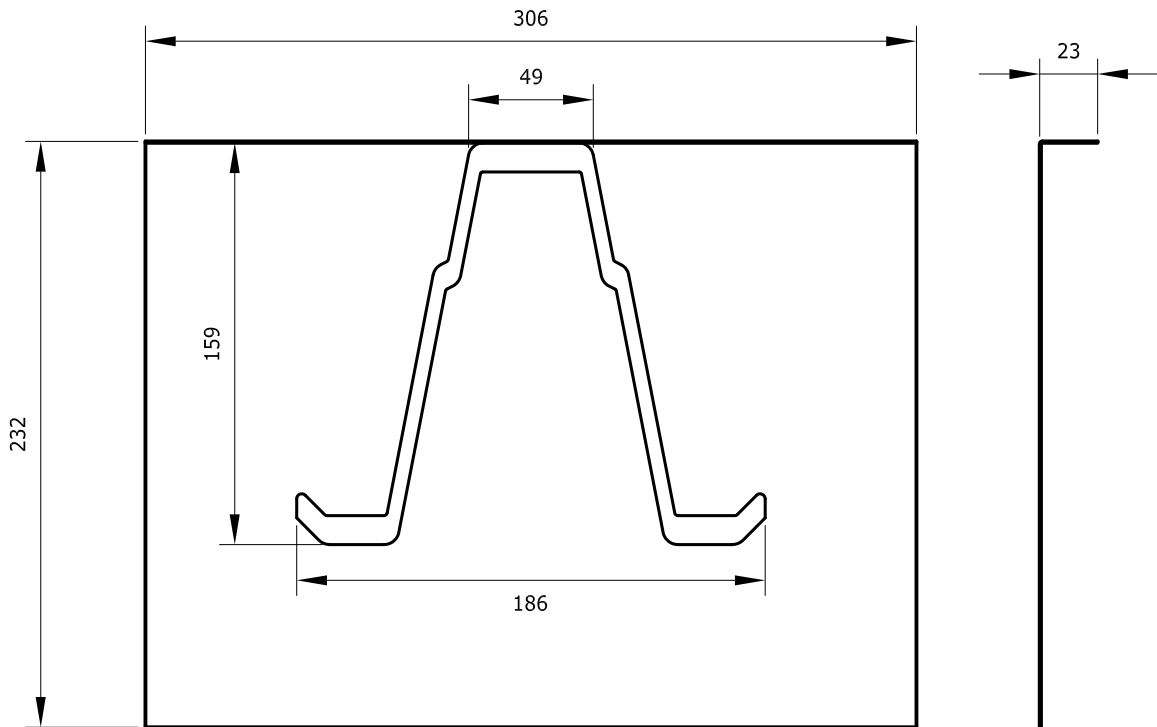

OPENING TO SUIT A SINGLE
OR LAPPED 150mm TOPHAT



ISSUE	NOTES	DATE			
TOLERANCES XX = ± 1.0 XX.X = ± 0.1 XX.XX = ± 0.03	TITLE THF150 210x306x23x0.55ZnAl		 16b Ormiston Road, East Tamaki, Auckland. Phone: 09 271 6834 Fax: 09 271 6835 Email: sales@rollforming.co.nz www.rollforming.co.nz Copyright Rollforming Services LTD ©		
	MATERIAL 0.55	STRIP WIDTH			
	FINISH ZnAl				
STANDARD TOLERANCES UNLESS OTHERWISE STATED	DRAWN D.S.	16Oct17	ALL DIMENSIONS ARE IN mm. - UNLESS OTHERWISE STATED. DO NOT SCALE - IF IN DOUBT, ASK. SCALE N.T.S.		
	CHECKED				
	APPROVED				
			DWG. No. THF150	A4	